

TAKE-A-LABEL

Operations Manual TAL-3100R

Round Product Label Applicator

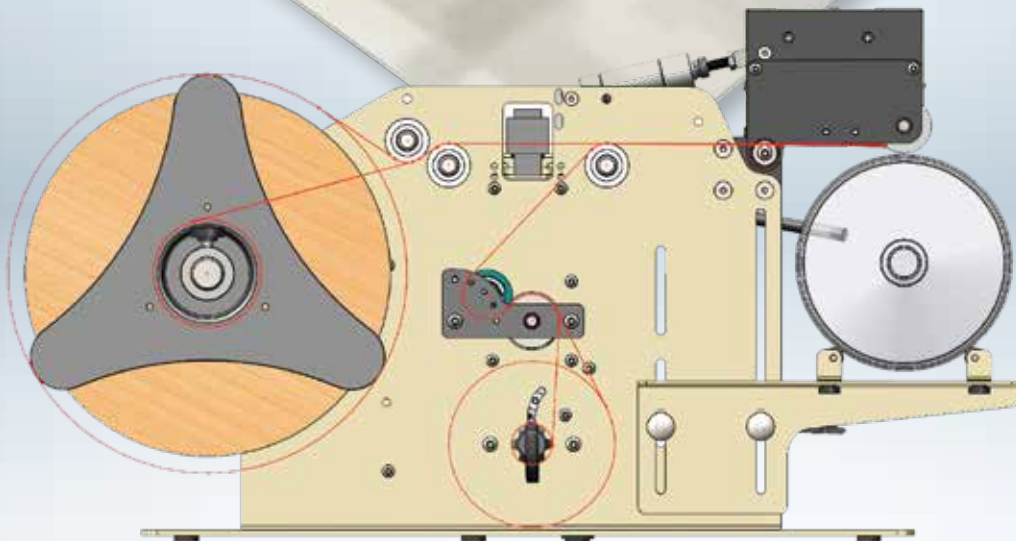

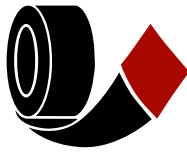

Helpful setup videos can be found on included USB or at www.take-a-label.com

1. Unpack TAL-3100R Label applicator from shipping container.
 2. Place the TAL-3100R on a firm level surface.
 3. Plug the TAL-3100R into an 110VAC 10 AMP Grounded outlet.
 4. Connect the labeler to a sufficient air supply. Minimum 80 PSI clean dry air.
- NOTE: The TAL-3100R typically operates around 30 PSI depending on the label.



LABEL THREADING

1. Remove outer unwind disc (48) install new roll of labels and replace disc.
2. Pull label web under the first roller, throw the photo eye (14). Continue pulling the label web over the top of the next roller. Thread webbing between the peel edge and the rubber drive roller (30). Then back towards the supply roll, over the idler roller.
3. Pull web down and wrap under the drive roller (24), and up between the drive roller (24) and pinch roller (17), then back down to the waist wind shaft (5). Note: The pinch roller (17) is spring loaded. Slight pressure will be needed to separate the pinch roller from the drive roller for threading.
4. Install waist wind clip (47) on waist wind shaft (5) placing the webbing between the shaft and the clip.

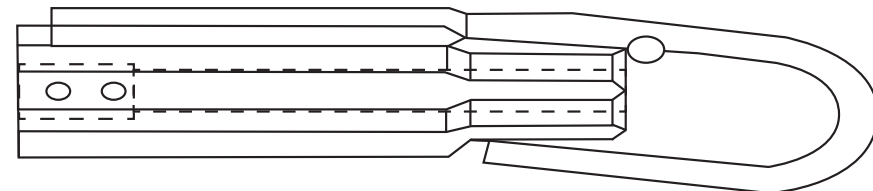
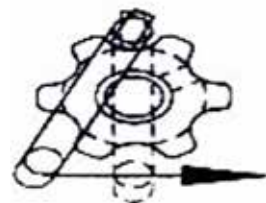

1. It is recommended that you teach the photo eye (14) with every new roll of labels used.
2. Remove one label from the webbing and place the webbing only in the photo eye.
3. Press and hold the “Normal” button on photo eye for 3 seconds. When the lights finish flashing the photo eye is taught.



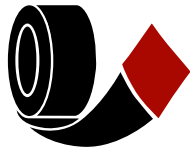

The label advance potentiometer resides on top of the TAL-3100R electrical housing. The purpose is to adjust the stopping position of the label with respect to the peel plate. With the label advance pot turned all the way counterclockwise the photo eye will stop the applicator instantly when it senses a gap. By rotating the potentiometer toward the + the applicator will dispense more of the label, and by rotating the potentiometer toward the - the applicator will dispense less of the label.

1. To setup the label position, rotate the label advance pot to the - as far as it will rotate.
2. The goal is to have the applicator stop with a label gap right at the peel edge.
3. Activate the applicator and watch the dispensing label. If the label does not advance far enough turn the label advance pot to the +, and repeat until one label is completely dispensed and the next label is stopped at the peel edge.



1. Keeping the product carriage table (34) level, raise or lower the product carriage by loosening the ratchet handles (2). With the Air System Disconnected raise the carriage to make contact with the Product Drive Roller (30).
2. Position the product rollers (44) with the center of the bottle under the Product Drive Roller (30).
3. Then manually raise the head 1/8" and raise the carriage again until it makes contact with the Product Drive Roller (30). Connect the Air system at this time.
4. The product should be setting on the product rollers (44) so it will roll easily. If the label tends to "walk" to one side of the bottle during application, the product rollers (44) may need to be repositioned. Some products may even require one of the product rollers (44) to be slightly skewed.

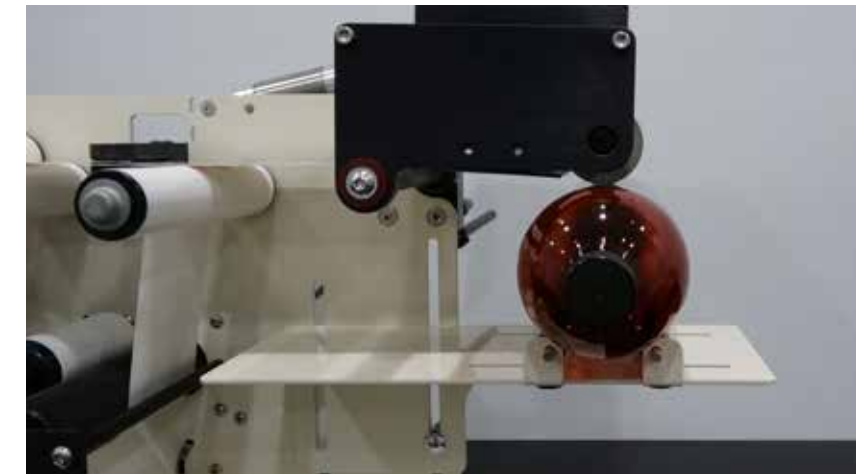

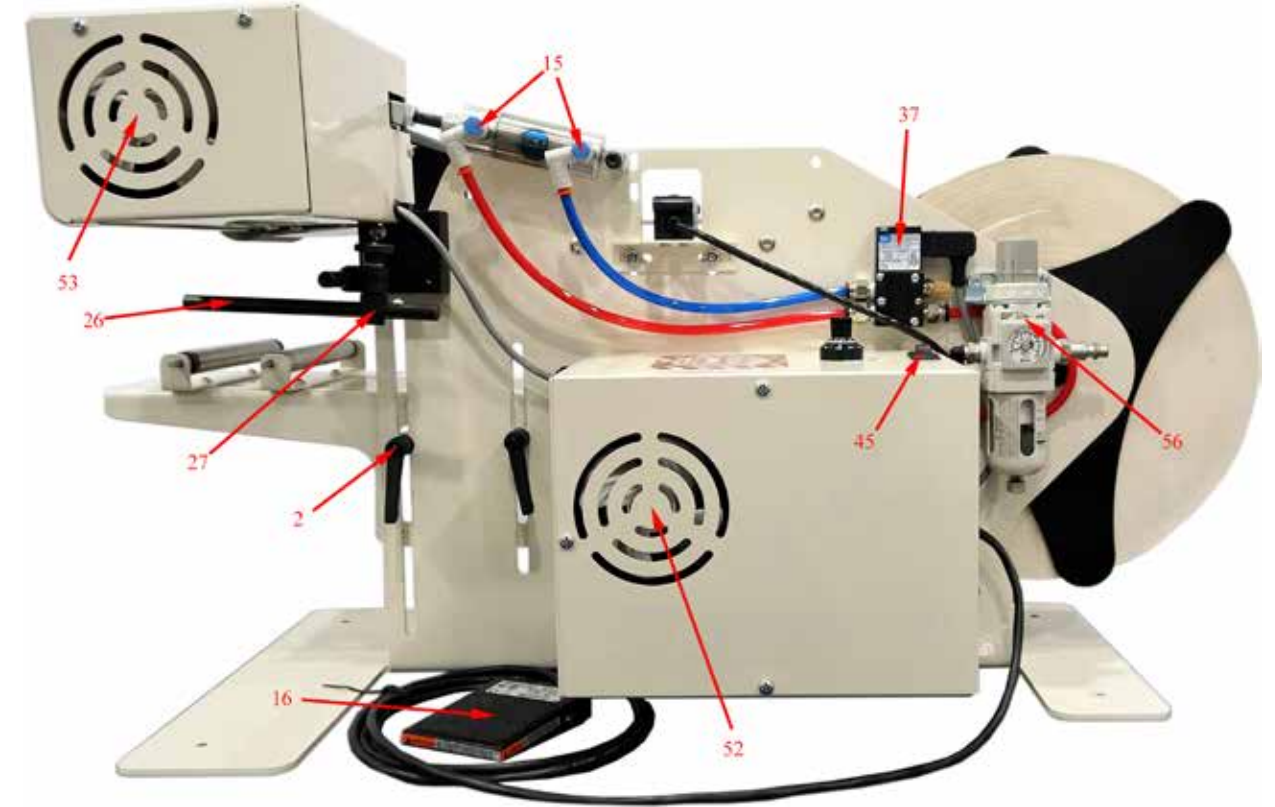
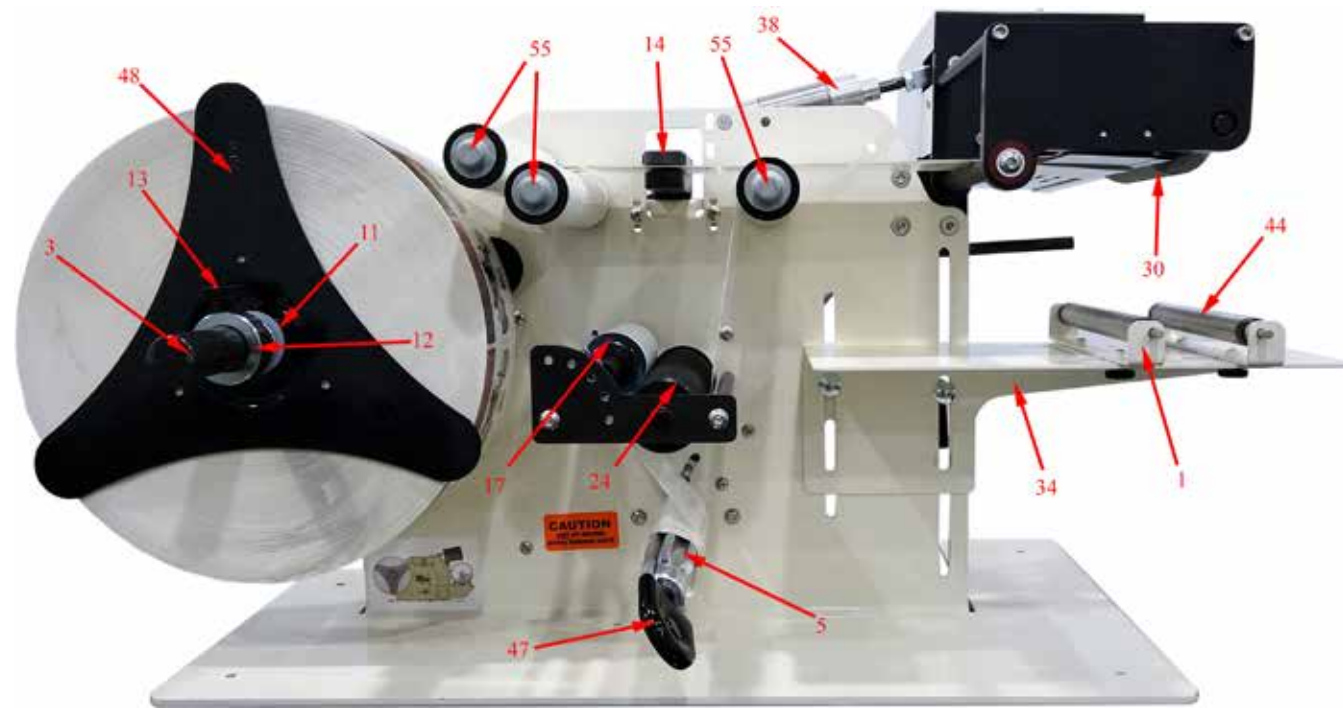
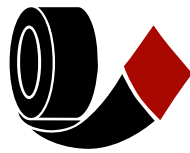

Item#	Description	#	Item#	Description	#
11004	Roller Support Bracket	1	31723	Flow Control	15
11007	Carriage Ratchet Handle	2	30110	Footswitch	16
11008	Unwind Shaft	3	31002	Pinch Roller	17
11010	Carriage Bolt	4	31015	Plastic Bearing	18
11016	Waste Wind Shaft	5	31017	Plastic Bushing	19
21031	Gates Drive Belt	6	31029	Plastic Bushing	20
21026	Motor Spacers	7	31060	Rewind Bracket	21
21027	Left Torsion Spring	8	31255	Control Board	22
21028	Right Torsion Spring	9	31282	V Belt Tensioner	23
25112	Washer	10	31355	Main Drive Roller	24
25113	Spring	11	31366	Extension Rod	26
26001	Collar	12	31370	3/8" x 3/8" Knuckle	27
26002	Hub Screw	13	31373	V Belt Pulley	28
30106	Tri-Tronics Photo Eye	14	31380	V Belt Tensioner Roller	29

Item#	Description	#	Item#	Description	#
31408	Product Drive Roller	30	37007	Product Rollers	44
31416	Label Advance Dial	31	40007	On/Off Switch	45
31417	Label Advance Pot with Wiring	32	45131	Clip	46
31721	Adhesive Backed Rubber Feet	33	45136	Unwind Disc	47
31802	Bottle Carriage Table	34	45155	Fuse Holder	48
31803	Threaded Guide Rod Support	35	45157	Fuse	49
31804	Cylinder Spacer	36	45217	Power Cord	50
31805	MAC Valve Kit	37	72618	Felt Pad	51
31806	Cylinder and Clevis	38	76800	Heavy Duty Motor	52
31818	Peel Plate	39	31839	Feed Head Motor (No Brake)	53
31832	Flanged Pulley	40	81912	Small Cord Grip	54
31833	Unflanged Pulley	41	21011	Idler Roller	55
31834	Timing Belt	42	30124	Filter Regulator	56
31835	Plastic Bearing	43			

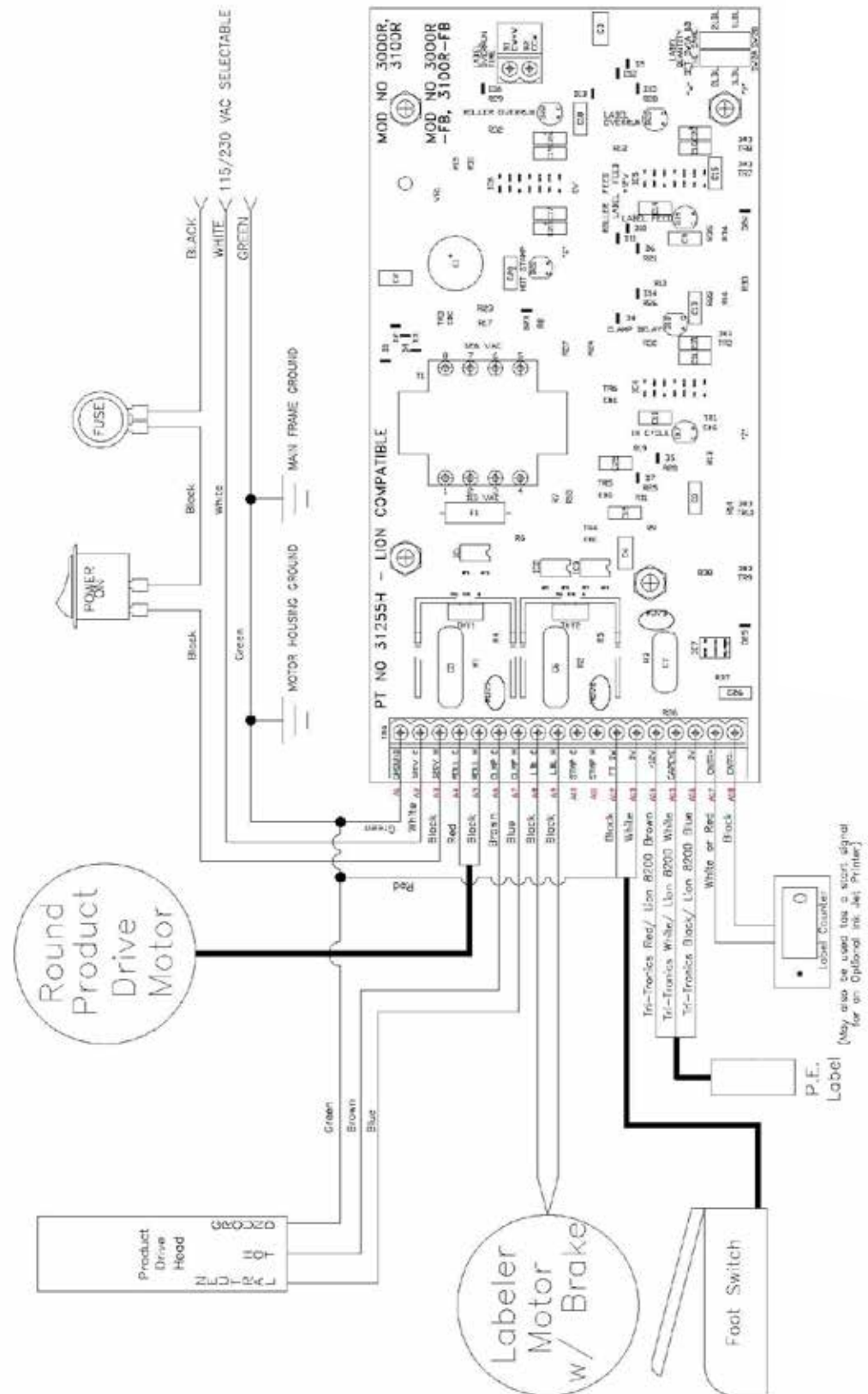
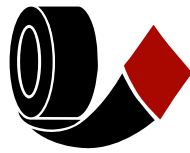

Item#	Description	#	Item#	Description	#
31002	Pinch Roller	1	31806	Air Cylinder	1
45131	Waist wind Clip	1	31255	Circuit Board	1
21031	Drive V Belt	1	72618	Unwind Felt Pad	3
31834	Timing Belt	1	45157	Main Fuse	1
45136	Unwind Disc	2	31375	Peel Edge Cover	1
76800	Label Drive Motor	1	31805	Valve Assembly	1
31839	Feed Head Motor	1	30106	Photo Eye	1
31408	Rubber Drive Roller	1	37007	Product Rollers	1
30110	Foot Switch	1	21027	Left Torsion Spring	1
			21028	Right Torsion Spring	1



Depending on frequency of use and importance of the machine function, this list may need to be modified to include more of each part to prevent any down time.

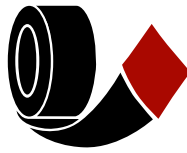

TAKE-A-LABEL

OPTIONAL ACCESSORIES

ALL PURPOSE CARRIAGE:

The All Purpose Carriage provides greater flexibility and adjustability than the standard bottle carriage. It is especially useful for larger bottles or containers that have lips or ridges that can affect how the bottle rotates in the carriage.



TAL-3100R CLEAR LABEL PHOTO EYE

LION 6300/8200 CLEAR LABEL PHOTO EYE:

1. Labels must pass under the "Sensing Area" indicator.
2. Remove a label and place the liner only in the sensor.
3. Press and hold the down arrow G button for at least one second. (Model 6300)
4. Press and hold both adjustment arrow buttons at the same time to set the sensor. (Model 8200)



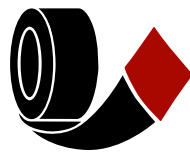

The registered ink imprinter allows you to imprint an alphanumeric code on the label prior to application to the bottle. This is commonly used for batch codes, expiration dates, or lot codes.

- To adjust the printing location left to right on the web. Loosen two knobs and slide coder to appropriate location.
- To adjust the printing location with the flow of the web. Slide the roller forward or backwards to achieve desired print location.

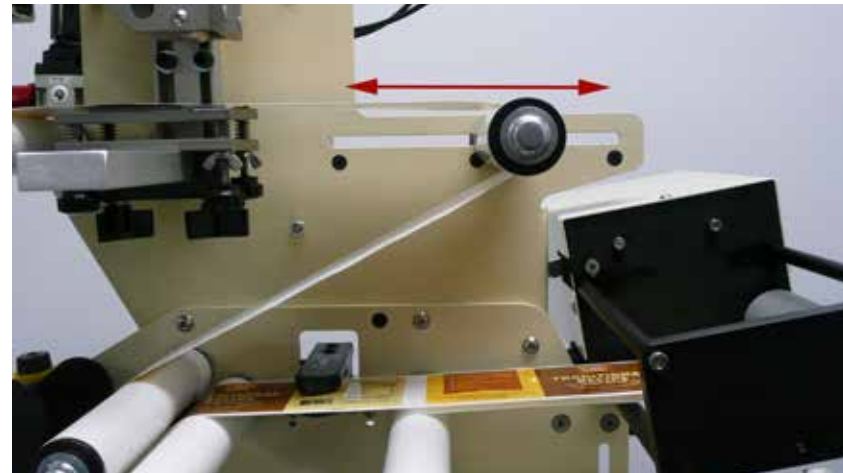

The Tapered Product Carriage is designed to assist in the application of labels to tapered bottles. For the tapered carriage to work properly the label must be crescent or arched in shape and match the taper/angle of the bottle.

1. Teach photo eye and set Label Advance per instructions on page 3 and 4.
2. First space two bottle support rollers to support tapered bottle
3. Tilt the carriage so when the drive head is lowered it hits the top of the bottle flush. The full length of the rubber product drive roller should hit even and flat across the top of the bottle.
4. Using the adjustment screws (A) in the back of the carriage set the stops for the rotation of the carriage. With the carriage fully rotated and bottomed out against the stop the bottle should match the taper on the edge of the bottle. Once the desired locations are found, use the set screws (B) in the rear of the adjustment blocks to snug onto the threads of the bolt. DO NOT overtighten the set screw as damage can be done to the threads on the bolt.
5. The unit is now be ready to apply the first label. If the first label is not applied square to the bottle, utilize the adjustment screws (A) to make minor adjustments. 1/2 of a turn on the screw will make a large difference in how the label is applied.



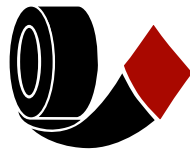

SETTING FIRST LABEL ADVANCE:

1. Turn both label advance dials counter clockwise to 0.0. Then turn label spacing dial to 5.0.
2. Cycle the machine. Focus only on the first label. Using the 1st label advance pot on the left. Turn the label advance pot clockwise until the gap between the labels stops on the peel edge.

SETTING SECOND LABEL ADVANCE:

3. Once the first label is dispensing and stopping at the peel edge focus on the second label. Use the 2nd label advance pot on the right to advance the label so it is completely dispensed and the applicator stops at the gap.

SETTING LABEL SPACING:

4. Use the Label Spacing pot to adjust the spacing between the front and back labels. Turning the pot to the + will increase the delay and your spacing between each label. Turning it to the - will decrease your delay and spacing.



The Smart Jet Inkjet printer will print on virtually any label stock. This printer is a great solution when you need to add an expiration date, a batch code or other information to a label prior to application. Using a wireless keyboard the printer is easily programmed. Using trusted Hewlett Packard technology and capable of printing up to 6 lines of information the Smart Jet Inkjet is a great solution for coding your label.

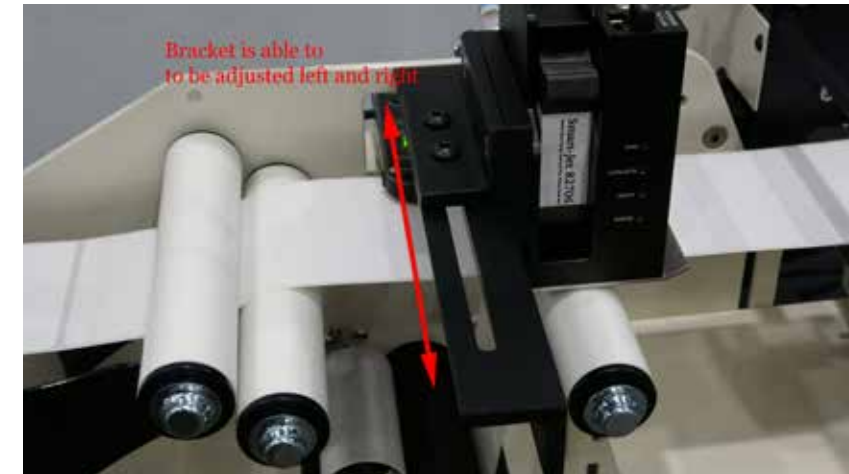

Found in the Settings changing the delay will move the location of the print on your label. Increasing the "Before" will move the print back and decreasing the "Before" will move it forward.

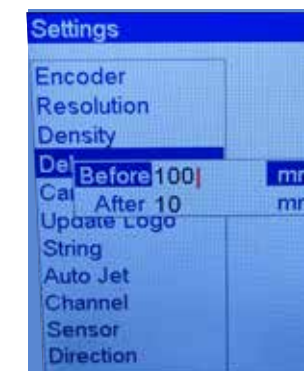

ALSO AVAILABLE FROM TAKE-A-LABEL, INC.

Do you need to label bags, boxes
or other flat products?

TAL-3100T
Tamp Applicator

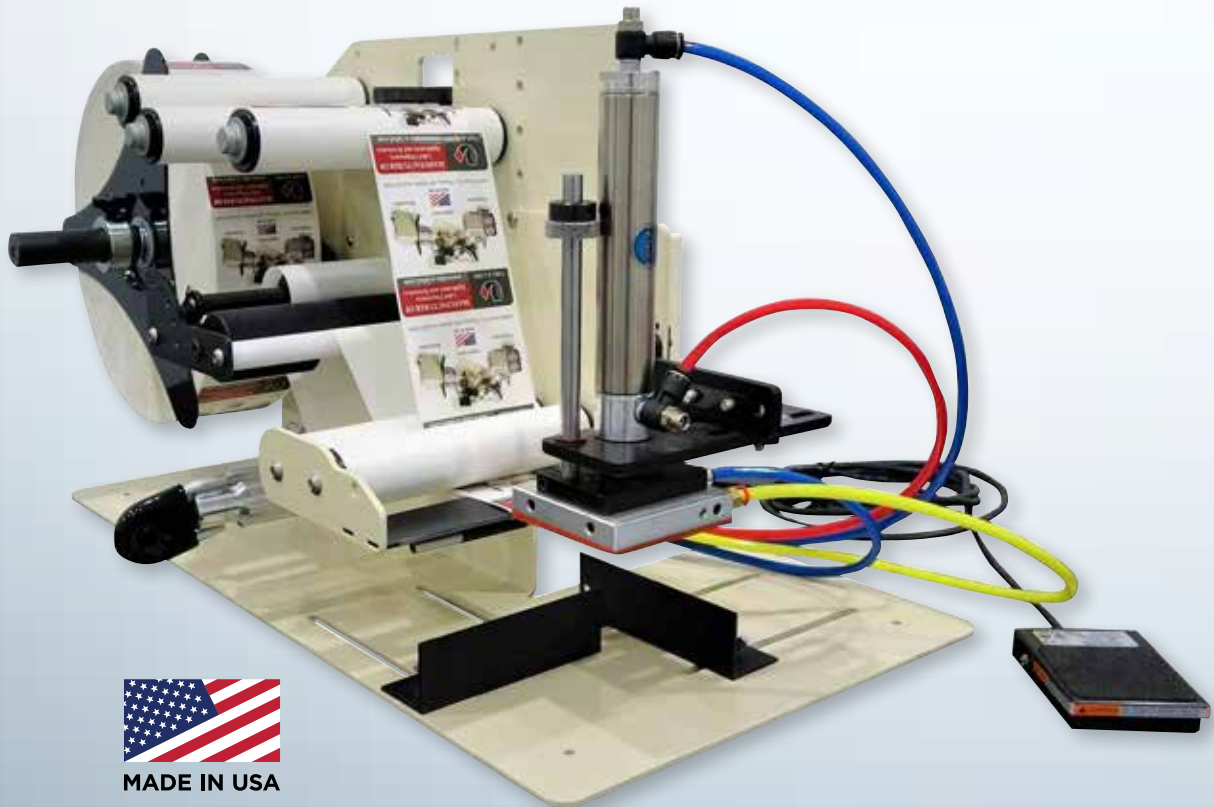

MADE IN USA



TAKE-A-LABEL, Inc.

The Industry Standard in Label Dispensers and Applicators

take-a-label.com • sales@take-a-label.com • 16900 Power Dr., Nunica, MI 49448 • 616.837.9300