

SGP-5000

Fully Pneumatic Piston Filling Machine

SGP Series



Operation Manual

(Please read it carefully before using the machine!)

ATTENTION:

Machine must be completely torn down, cleaned, sanitized, and lubricated with H3 food grade lubricant prior to use. A recommended lubricant has been provided.

This machine requires an air compressor.
We would recommend a 20+ gallon compressor.
The air requirements for this machine are 5cfm@90psi.



Table of Contents

Chapter 1 Overview.....	3
1-1 Overview	3
1-2 Features	3
1-3 Parameters.....	3
1-4 Working Principle	3
1-5 Working Process	5
1-6 Available Range	5
1-7 Introduction to Parts and Specifications.....	6
Chapter 2 Operation Instruction.....	7
2-1 Preparation.....	7
2-2 Operation Method.....	8
2-3 Fault Analysis and Troubleshooting.....	9
2-4 Safety Instruction.....	10
Chapter 3 Rotary Breakdown Assembly	11
3-1 Machine Specification – O-ring List.....	11
3-2 S Series Filler Breakdown	12
3-4 Seal Breakdown	31

Chapter 1 Overview

1-1 Overview

The SGP series fully pneumatic filling machines are newly designed for liquid, paste, and cream filling, and its filling amount can be adjusted as required based on the specified range, featuring high stability, reliability and filling accuracy.

1-2 Features

1. All surface materials of this machine are crafted of 316 stainless steel, which features high acid-resistance and corrosion-resistance properties, as well as presenting a high quality finish.
2. You can operate it safely and easily and adjusting the filling amount can be performed within the range as required with high accuracy.
3. Its reasonable layout enables you to easily disassemble, safely operate, and easily clean the filler.
4. Due to a total lack of electrical components, this filler can be used safely in a wide array of hazardous or moist environments.

1-3 Parameters

Item		SGP-5000
Available range		Cream/Paste/Liquid
Filling range	Cream	550-5000ml
	Liquid	-
Filling accuracy	Cream	±2%
	Liquid	±1%
Working air pressure		0.4-0.5MPa
Throughput		0-30 bottle/minute
Outline (length x width x height)		-
Net weight		-

Note: For this series of machine, the maximum liquid amount to be filled should be less than 5%-10% of the cream amount.

1-4 Working Principle

The cylinder runs in reciprocating and linear manners to drive the piston and generate suction and thrust so as to draw and push your product.



1-5 Working Process

Open the inlet valve, adjust the working air pressure and select the working status (automatic or semiautomatic). During the operation, the rotary cylinder linkage is turned (opens a path towards the front while sealing towards the top), the fill head cylinder moves upwards to open the discharge valve, the piston cylinder actuates to move the piston forward, which dispenses material for filling (the speed can be adjusted by the “Behind” valve); after that, the fill head cylinder moves downwards to close the discharge valve to prevent dripping, the rotary cylinder linkage returns (seals towards the front while opening a path towards the top), the piston cylinder actuates to move the piston rearward, which pulls new product into the chamber for the next filling (speed can be adjusted by the “Front” valve). Thus the operation is accomplished.

1-6 Available Range

It is ideal for special industries such as food, daily chemistry, pesticide and medication.

1-7 Introduction to Parts and Specifications

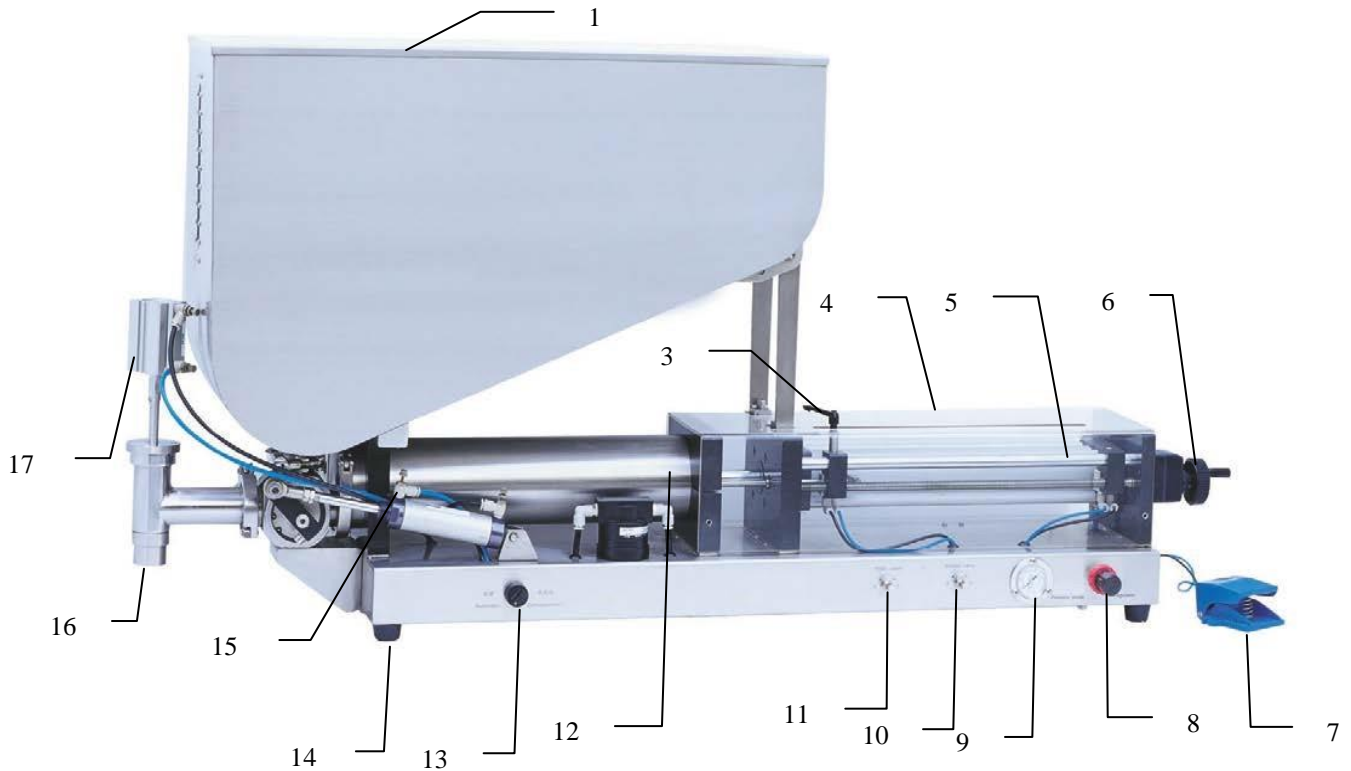

1. Hopper
2. Main air cylinder
3. Adjustable lock handle/sensor
4. Protective covering
5. Crossmember
6. Foot pedal
7. N/A
8. Air regulator
9. Air gauge
10. Behind valve
11. Front valve
12. In-line air filter
13. Automatic/semiautomatic switch
14. Underchassis
15. Rotary assembly
16. Fill head assembly
17. Fill head air cylinder

Chapter 2 Operation Instruction

2-1 Preparation

1. Precautions

- (1) The inlet air pressure should be 0.5-0.8Mpa and the working air pressure should be 0.4-0.5 Mpa.
- (2) Keep all appendages clear of moving parts during operation.

2. Filling amount troubleshooting

Adjust the filling amount as follows:

- (1) Put materials to be filled into the container.
- (2) Prepare measuring cup or scale to identify quantities desired.
- (3) Turn the hand wheel to adjust the variable sensor to desired range.
- (4) Check to ensure that the operation switch is set to Semiautomatic, use the foot pedal to control the cycle, measure the obtained product to see whether it is in the desired quantity. If not, proceed by the the following:
 - A Loosen the locking handle on the adjustable sensor.
 - B Turn the hand wheel clockwise or counterclockwise.
 - C Repeat step 4, using a measuring cup or bottle to measure the materials and adjust the handwheel until the obtained result is within the desired range.
 - D Tighten the locking handle on the adjustment sensor to avoid parts shifting and influencing the filling accuracy.

2-2 Operation Method

- (1) Connect the air source and slide the air inlet collar towards the machine.
- (2) Check whether the air pressure meter is in the specified range (roughly reading in the “12-3 o’clock” range). If not, draw the air pressure knob outwards to unlock, rotate the pressure regulator knob until the pressure is in the specified range (0.4-0.5Mpa) and push the knob back in to lock.
- (3) Use the Auto/Semiauto switch to set the filler to the desired operation method.
- (4) To make an adjustment, you can loose the locking handle on the adjustment sensor, rotate the handwheel, take note of the value on the position display and fasten the handle.
- (5) Adjust the front valve (for adjusting drawing speed) and behind valve (for adjusting filling speed) as shown in Figure 1 to get reasonable drawing and filling speed.

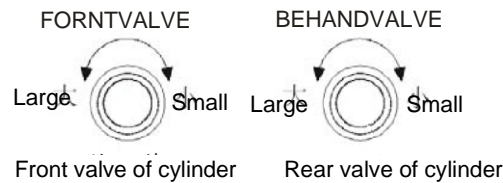

Figure 1

- (6) Fill the hopper with product and prepare the container to be filled.
- (7) Proceed with filling and control the operation with the foot switch. Step on the foot switch once to cycle a complete filling operation. You can adjust and use the Automatic function if you are proficient enough to keep up with the filling speed.



2-3 Fault Analysis and Troubleshooting

Symptom	Analysis	Troubleshooting
The machine fails	Check whether the air pressure collar is open	Open it
	Check whether the air source is open (compressor)	Open it
	Check whether the value on air pressure meter is in the correct range	Adjust it to 0.4-0.5MPa
	Check whether there is leakage on any air fittings or damage on air lines	Insert the air line again or change another one
	Check whether air amount is adjusted to the minimum (tightened too much) via the front valve and behind valve	Adjust the valves to the working status
	Check whether the air amount on the fill head cylinder is adjusted to the minimum (tightened too far)	Adjust the throttle to the working status
	Check cleanliness of machine. Product may be hardened, tacky, or sticky, causing rotary assembly or main piston to be stuck	Clean the machine
Filling is not even	Check for air leakage in all air line connections	Fasten each joint
	Check for leakage in the product chamber	Replace o-rings
	Check product level inside hopper	Add materials
	Check for correct speeds during filling and drawing actions	Adjust the front valve and behind valve for stable operation
	Check whether the material viscosity is even	Agitate product



2-4 Safety Instruction

1. You can use soap and warm water to clean the machine. Fill hopper with cleaning agent and water; cycle until discharge is clear of any product; fill hopper with clean water and cycle until water is clear
2. Never use sharp tools on any parts surface when cleaning the internal parts and install the parts when they are dry.
3. Use lubricant for all moving parts.
4. Check the o-rings of all parts and replace damaged rings.
5. Check whether there is damage or leakage on the air lines.
6. Fasten screws of all parts.
7. Never clean the filler via harsh or abrasive cleaners to protect the machine integrity.
8. Never cycle the filler without a product.
9. Never put hard materials into the hopper.
10. Filler should be on a flat surface in a dry place with little dust and enough room for movement during each filling cycle.
11. Use the machine in air-current environment when volatile liquid is to be filled.
12. Body or materials should be far away from moving parts and our factory takes no responsibility for any machinery and human injury due to it.
13. Cut off the air source when repairing/replacing parts/cleaning.
14. Never use an organic flux to clean the machine, such as gasoline, acetone, benzene, xylene, banana oil or sodium hypochlorite.

Chapter 3 Rotary Breakdown Assembly

3-1 Machine Specification – O-ring List

Machine comes standard with buna o-rings

Piston: 7x135.89

Rotary: 3.5x57

Fill Head: (Several Pieces)

Nozzle: 3x36

Plunger: 4x28

Shaft: 3x11

Upper, Outer: 2.65x38

Upper, Inner: 2.5x19

Rotary to chamber gasket: 6.5 inch “ID” and 7.5 inch “OD” (Inside/Outside Diameter)

Rotary to hopper gasket: 2 inch TC (tri-clamp)

Rotary to fill head gasket: 2 inch TC (tri-clamp)

Rotary flange o-rings: 2x42

Rotary bearings: 6/32 DU, 6008 DU

3-2 S Series Filler Breakdown

How to break down the rotary

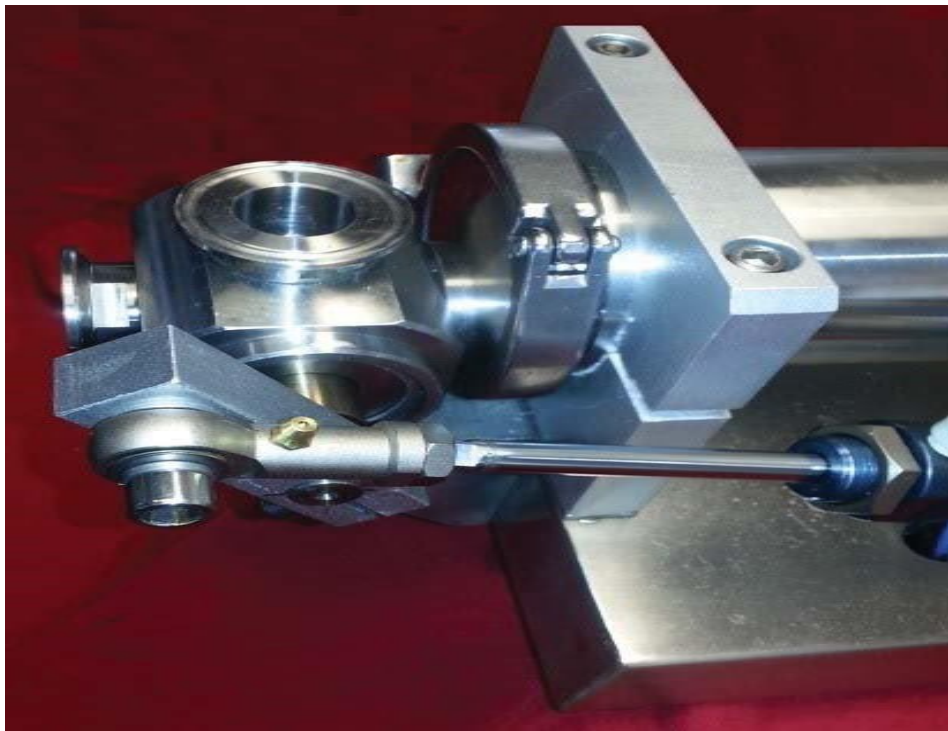

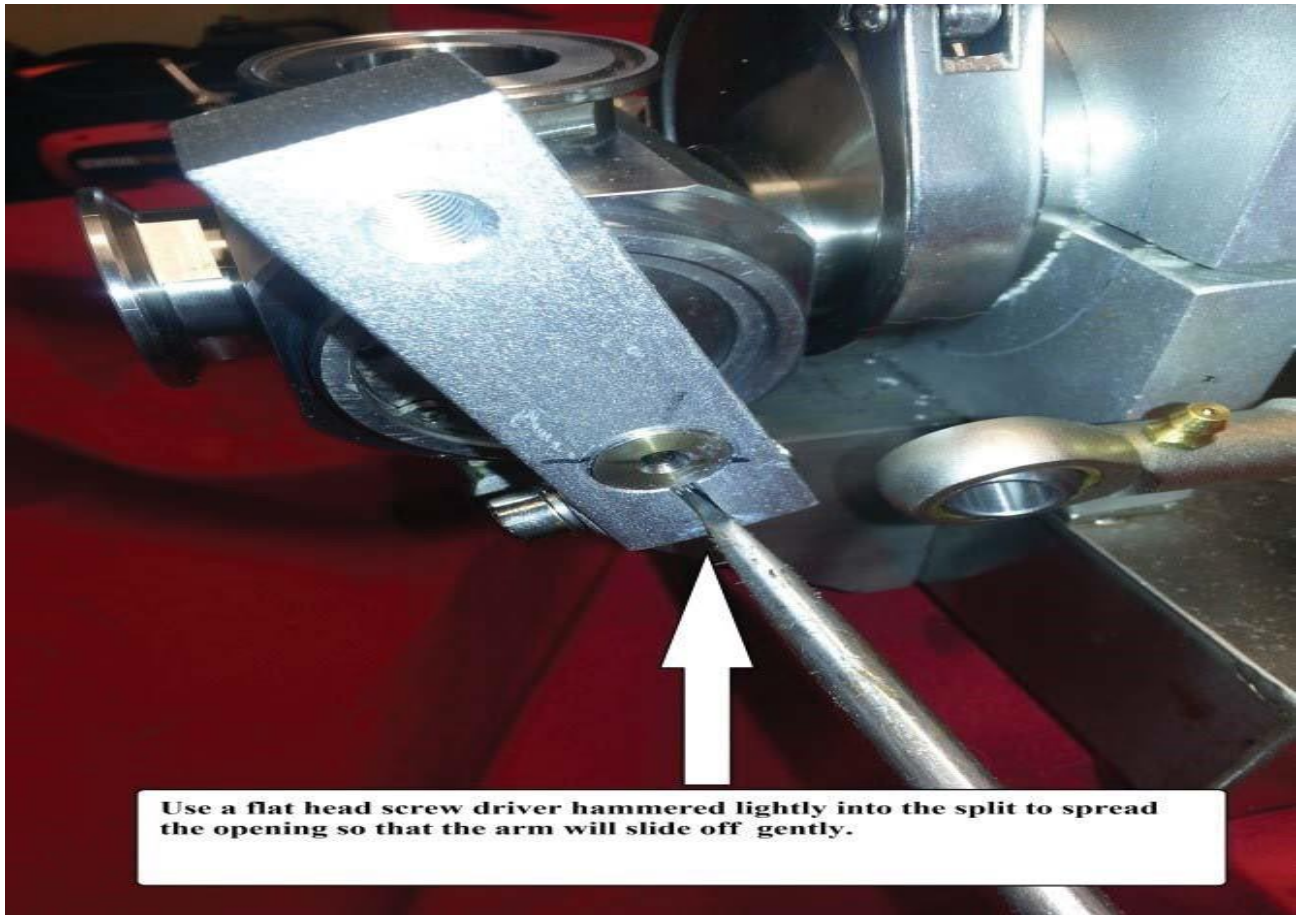
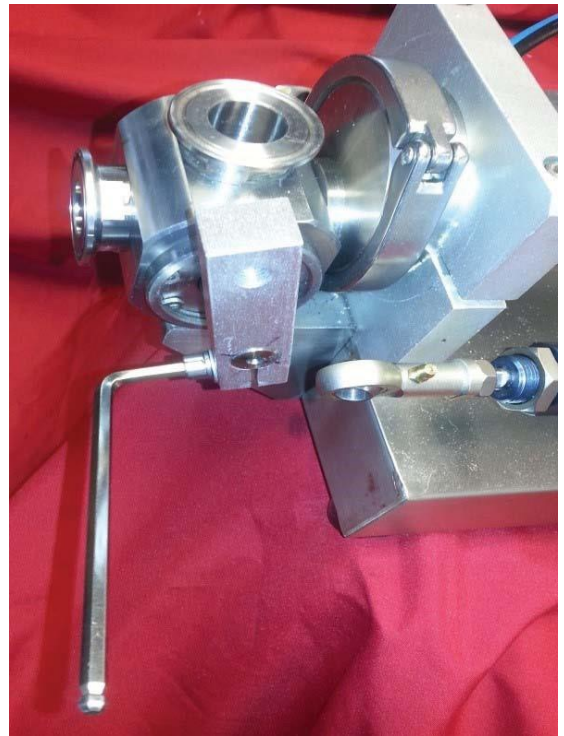
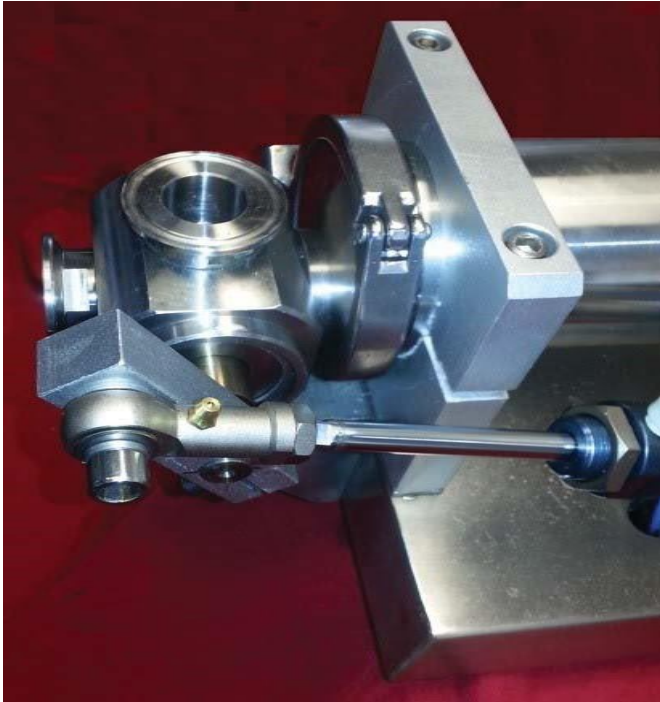

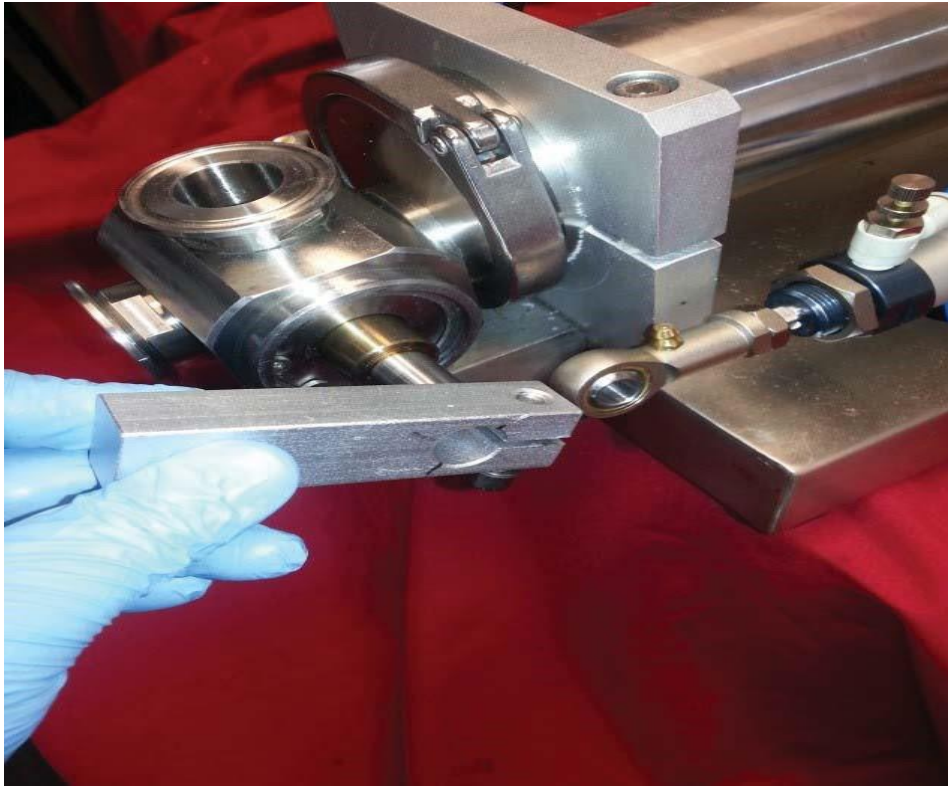

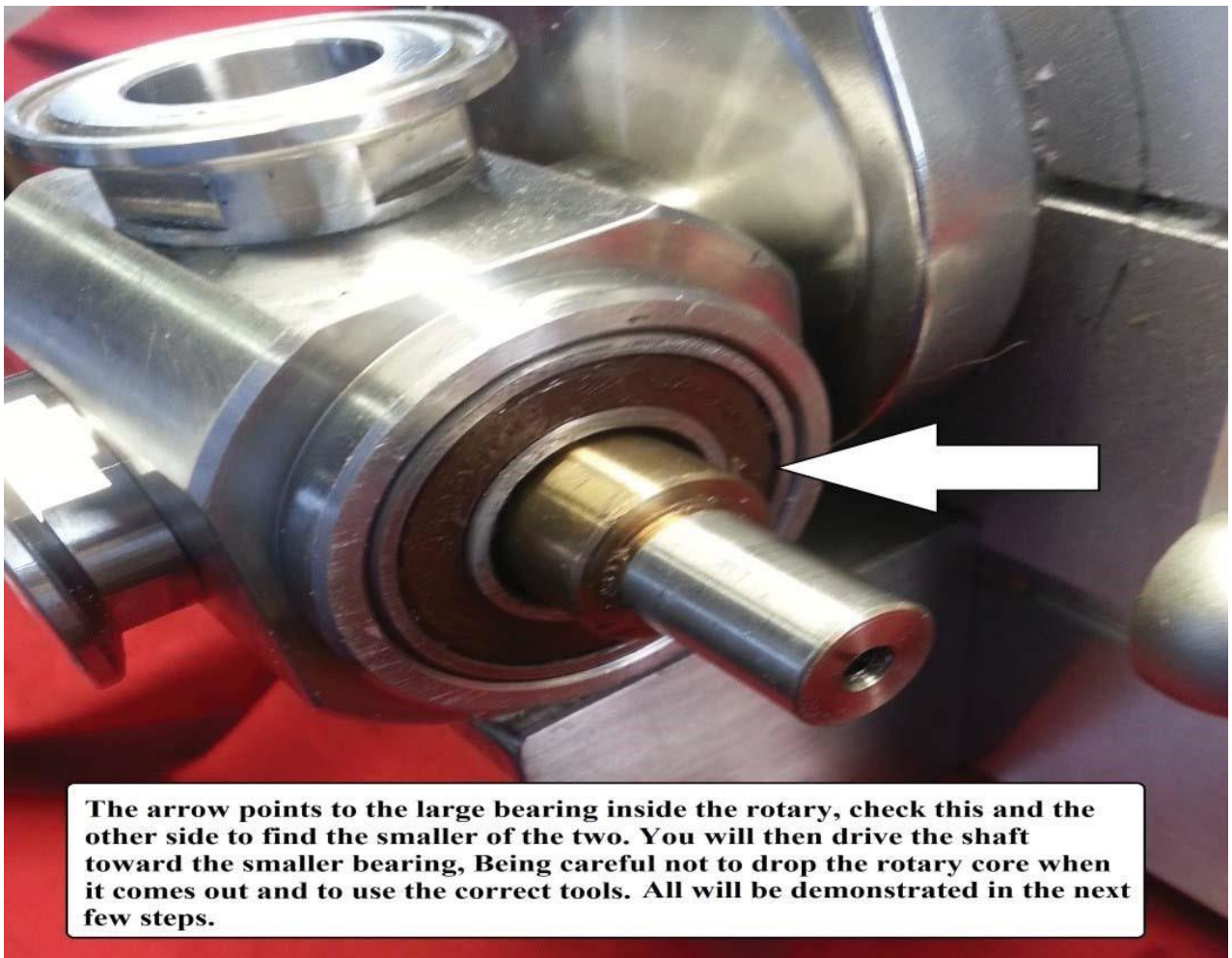

The arrow points to the large bearing inside the rotary, check this and the other side to find the smaller of the two. You will then drive the shaft toward the smaller bearing, Being careful not to drop the rotary core when it comes out and to use the correct tools. All will be demonstrated in the next few steps.

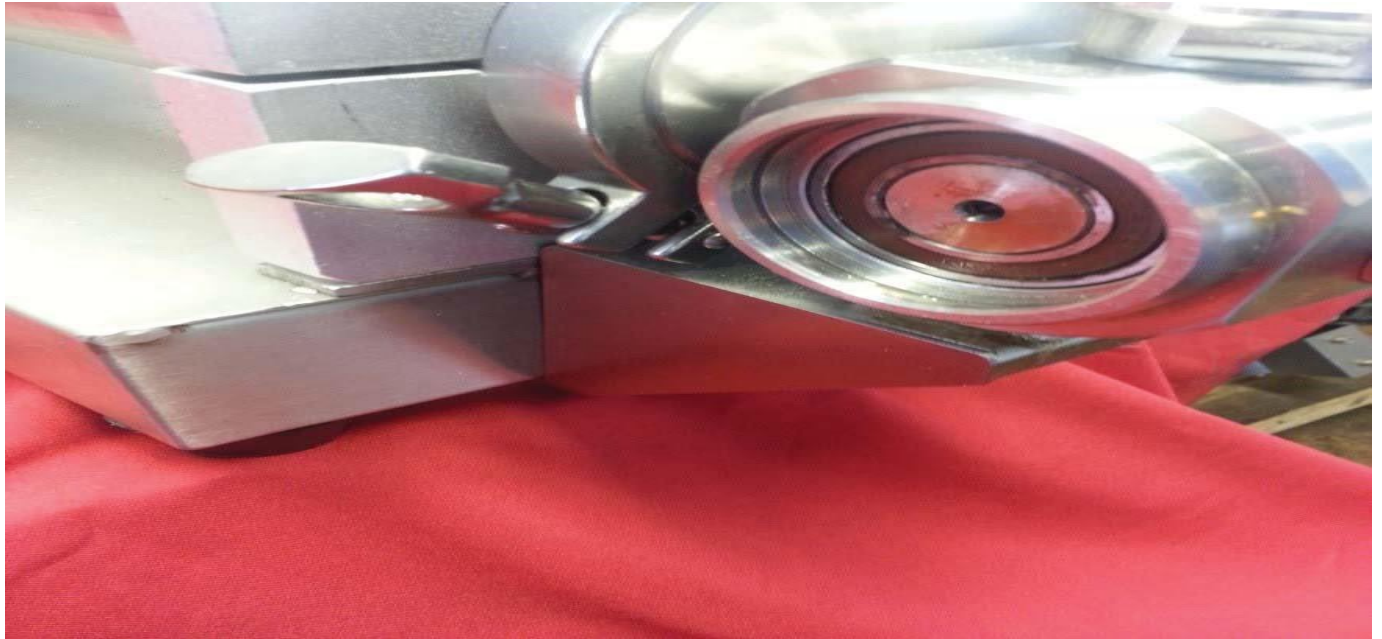

**The bearing shaft driver
DO NOT hit directly on the shaft us this tool**



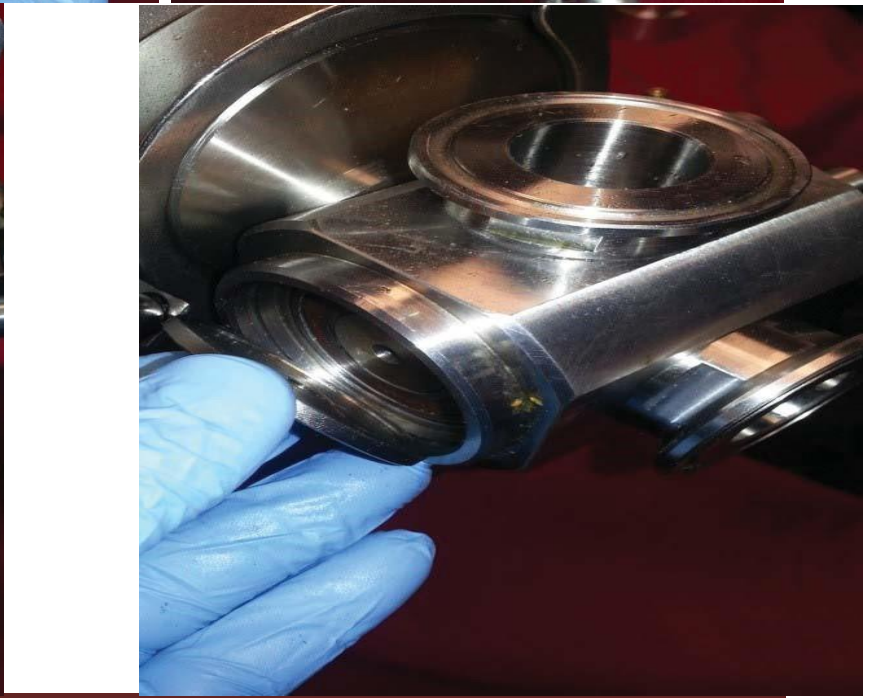
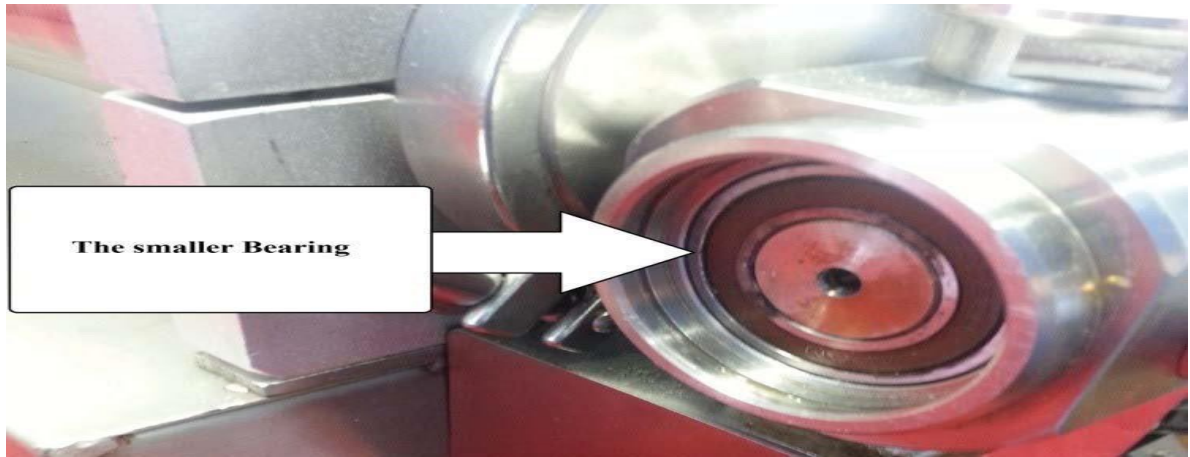

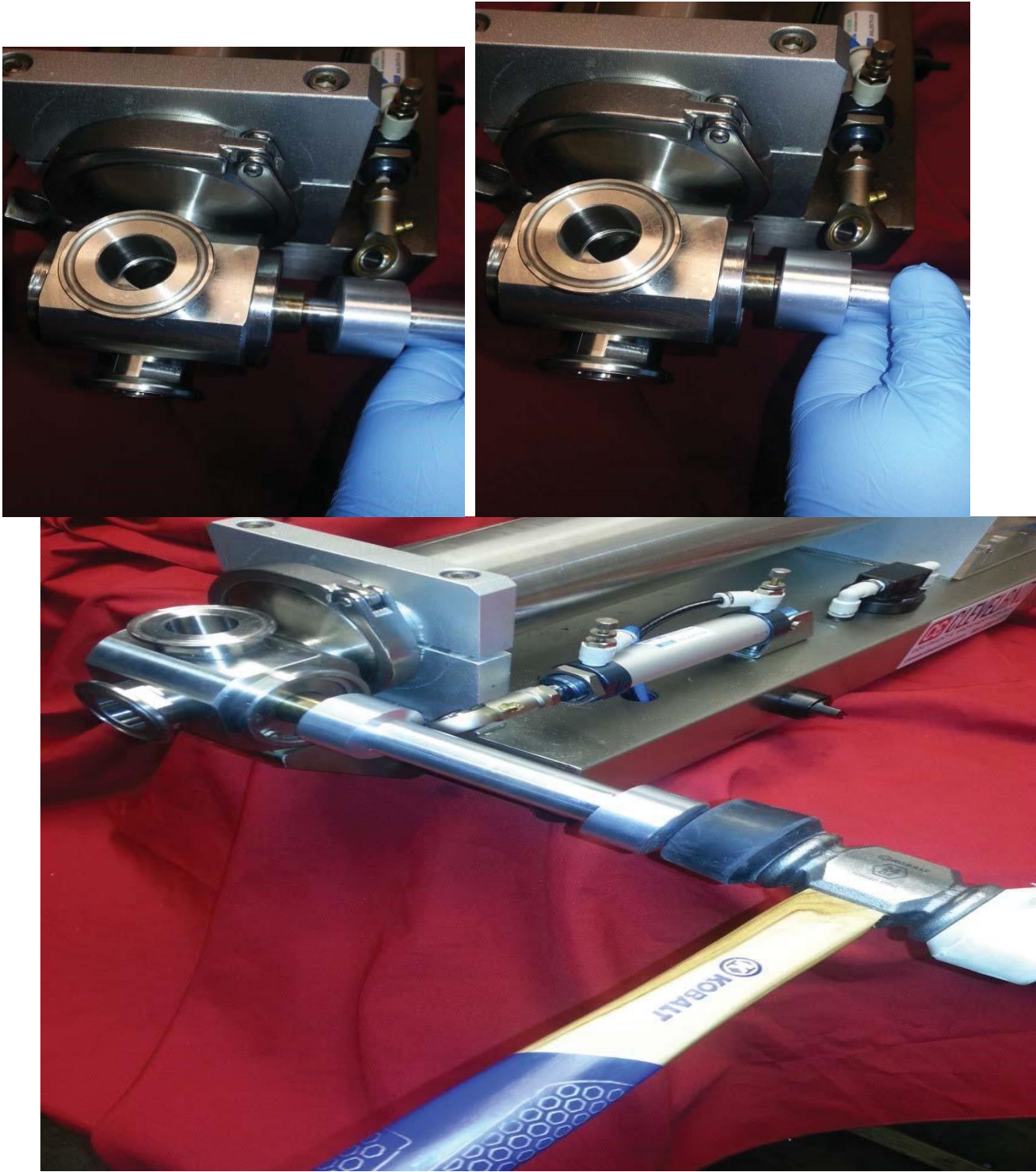





Cylinder removal and piston check

to put the cylinder back together please reverse these steps

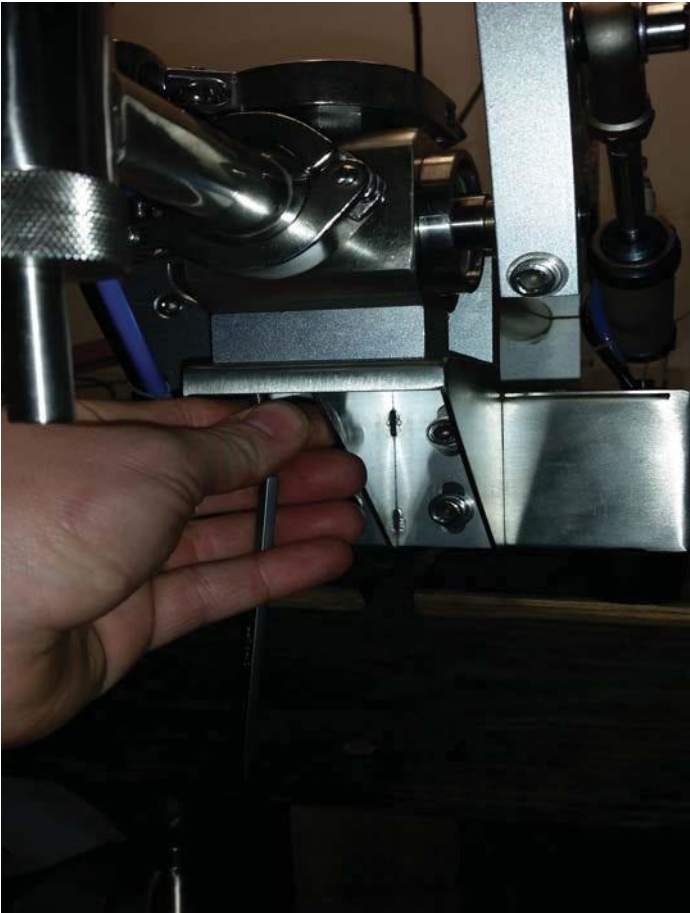
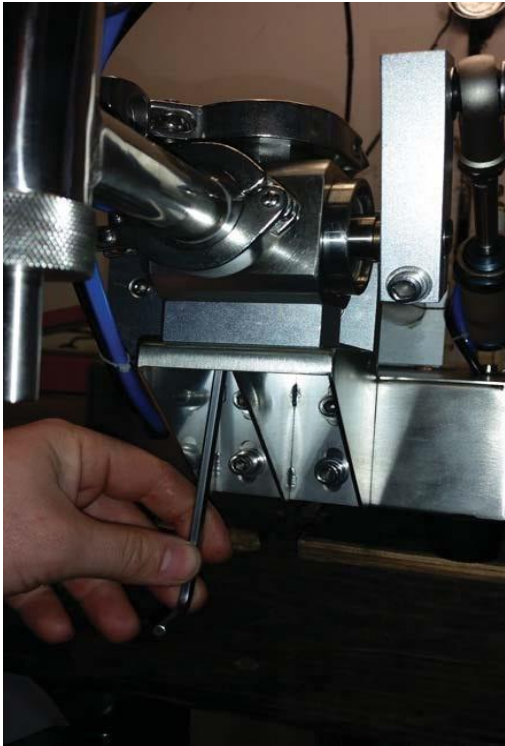

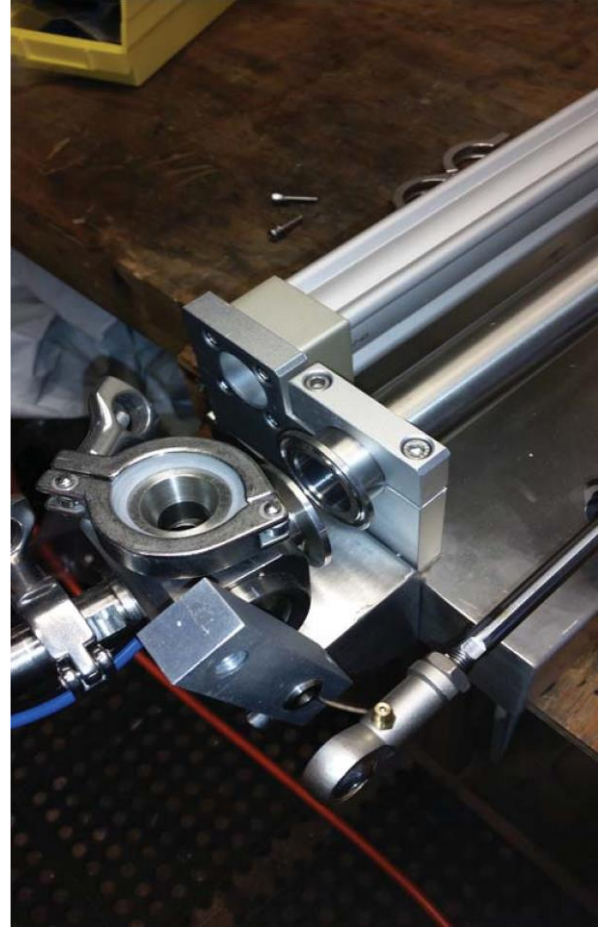
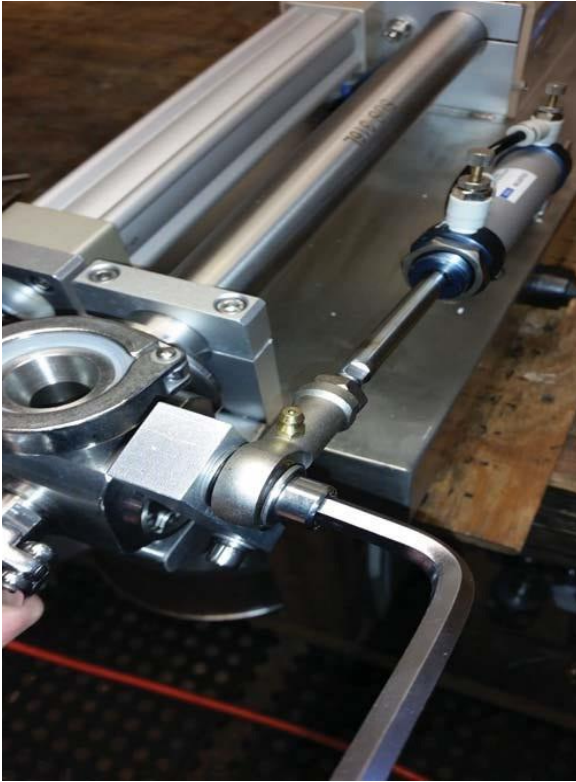

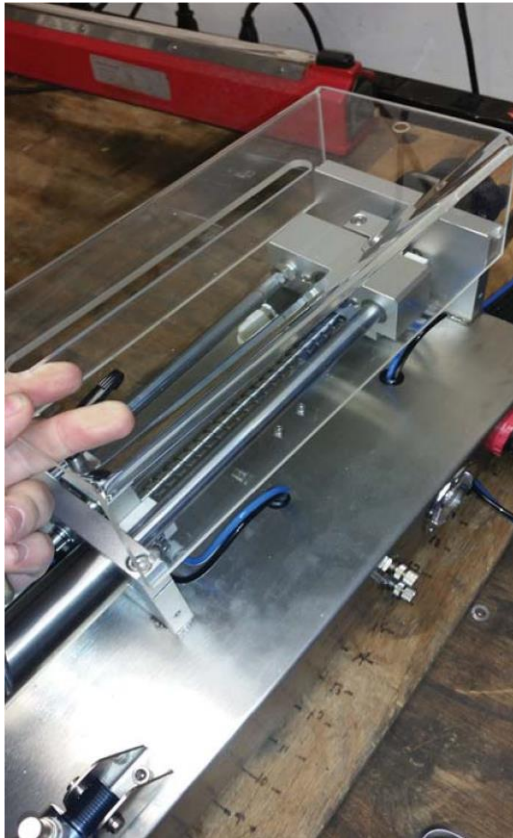



How to rebuild the rotary



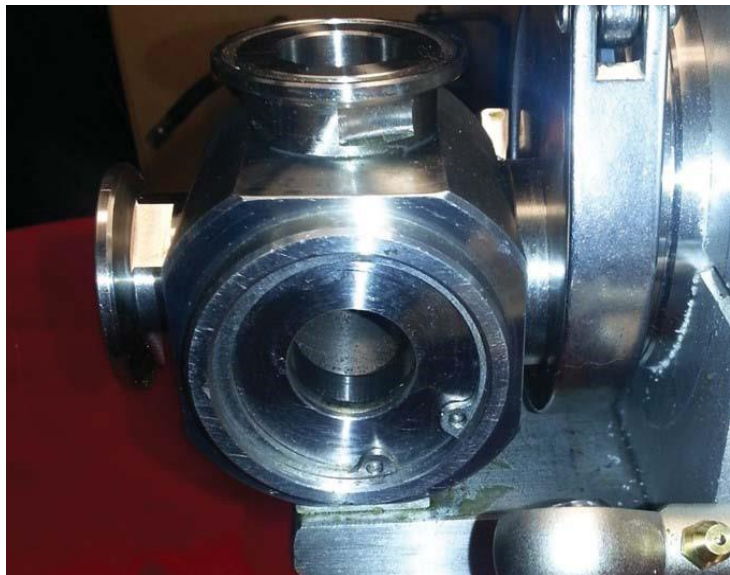
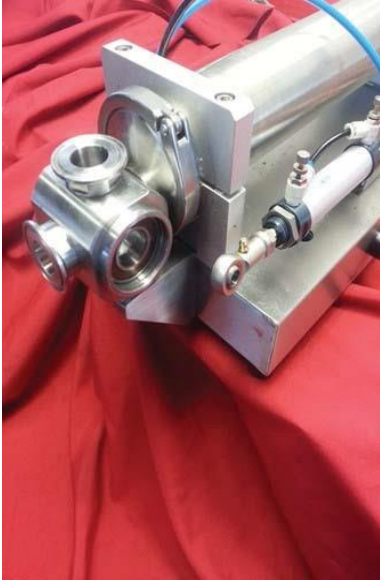

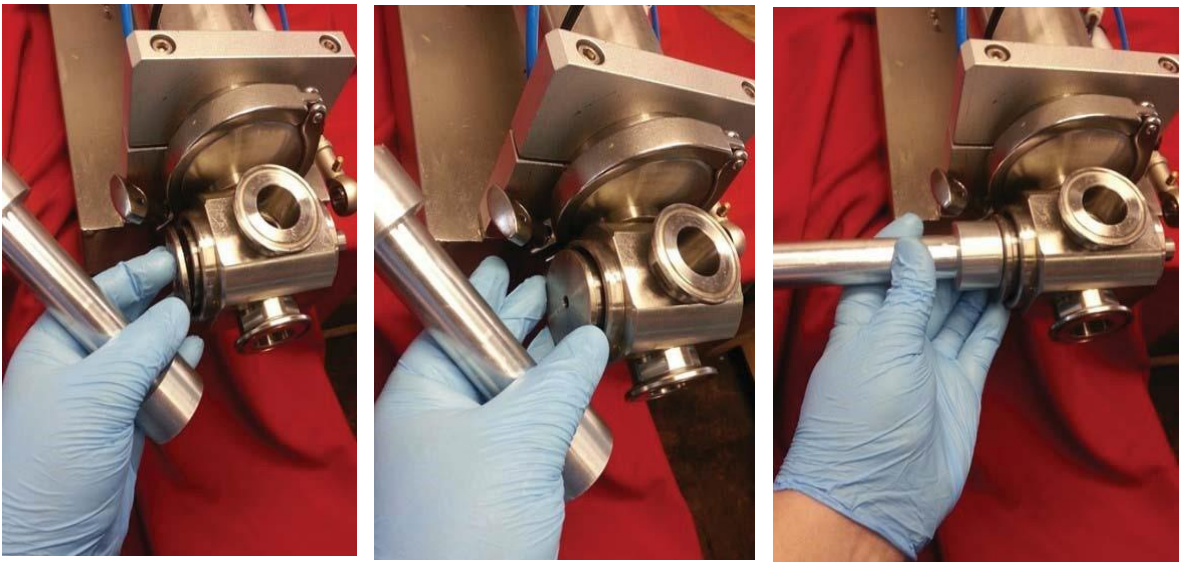
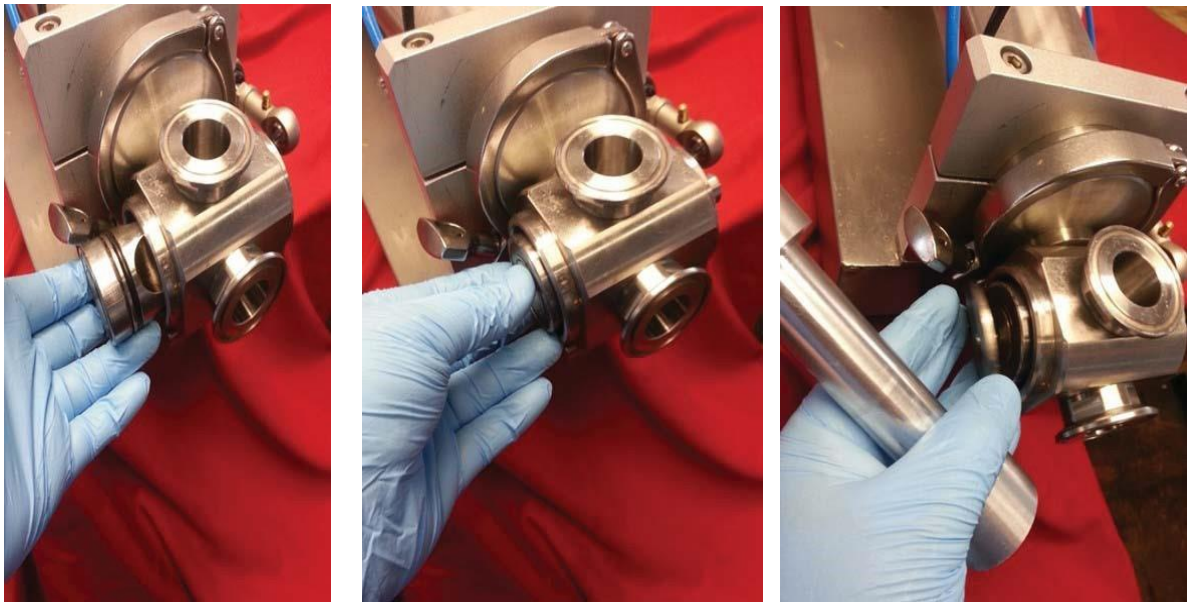

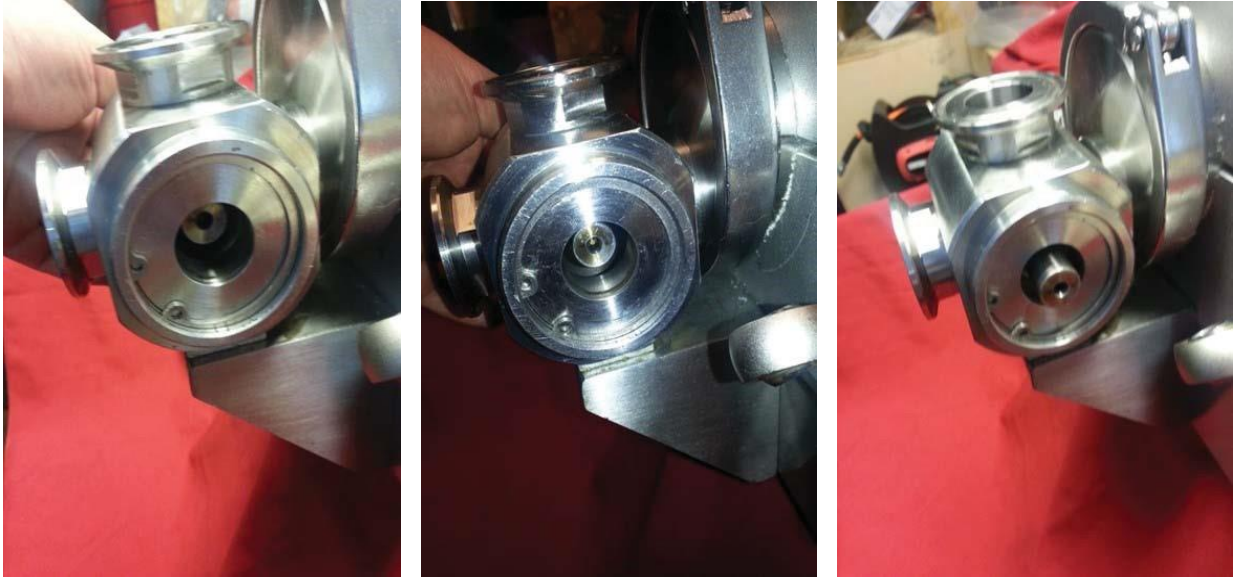

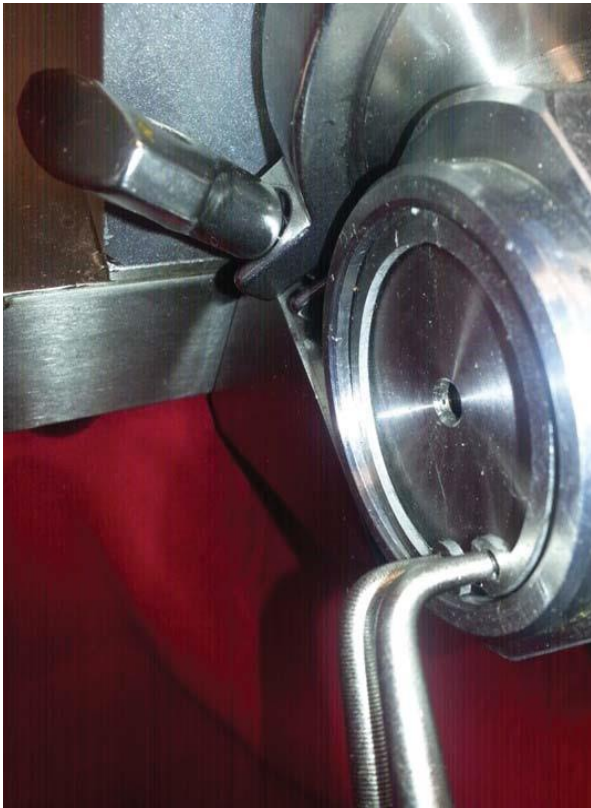

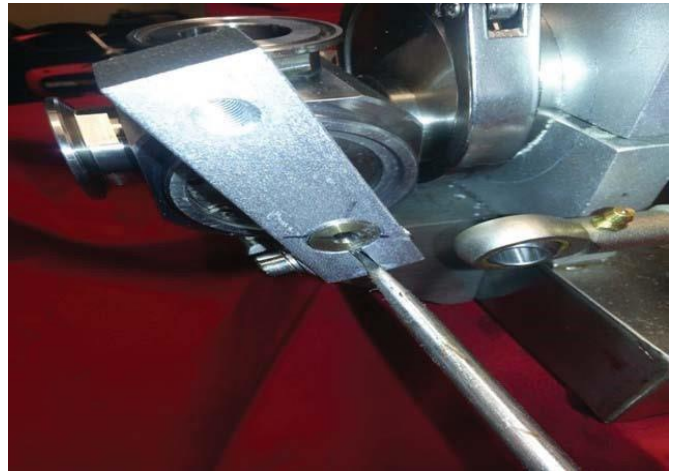

3-4 Seal Breakdown

Seal Breakdown

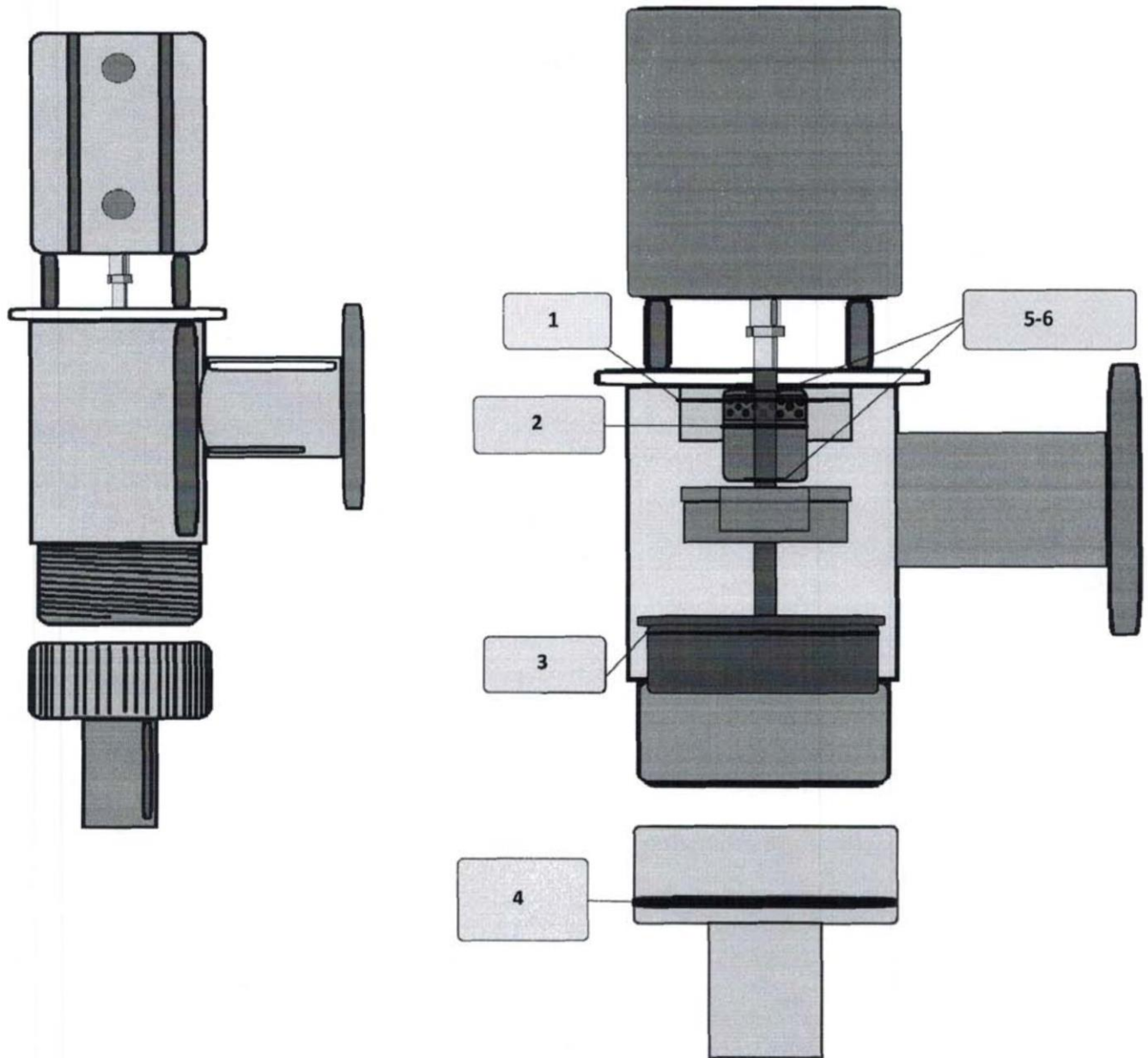

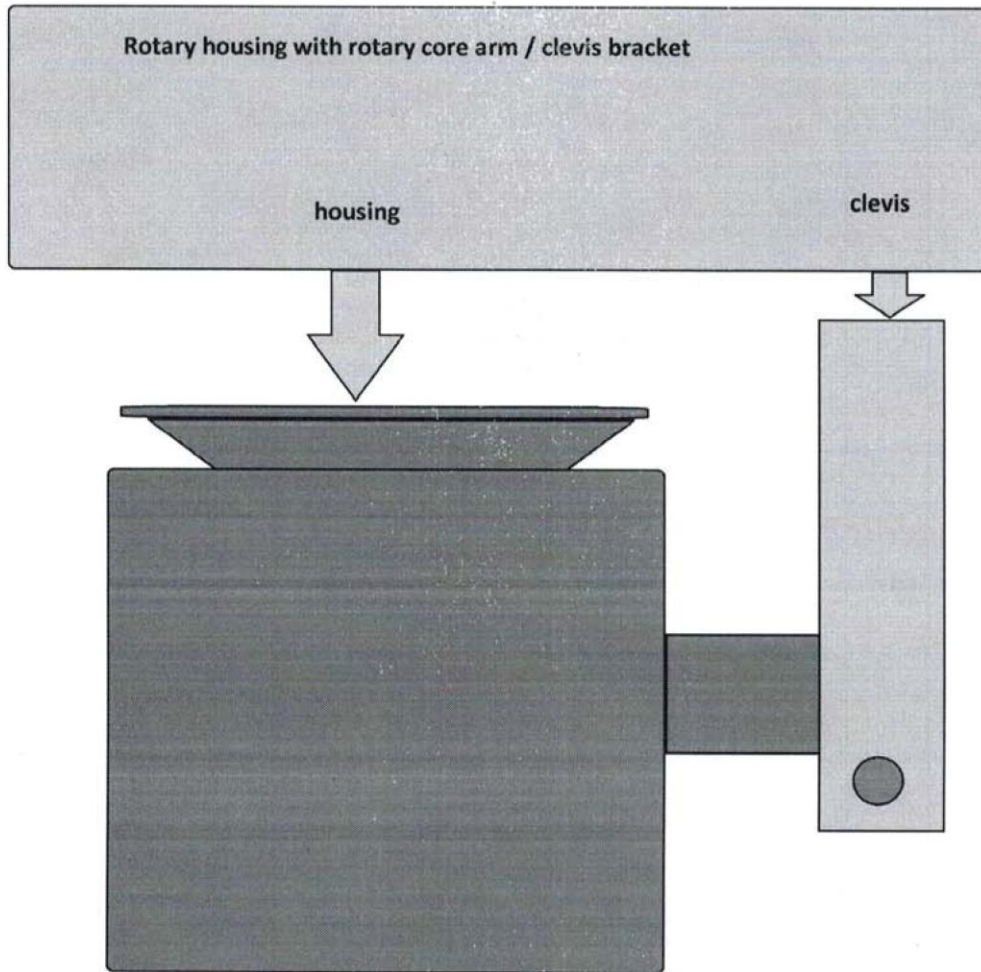

Rotary core in home position, the core arm/clevis will be facing up and in the forward most position

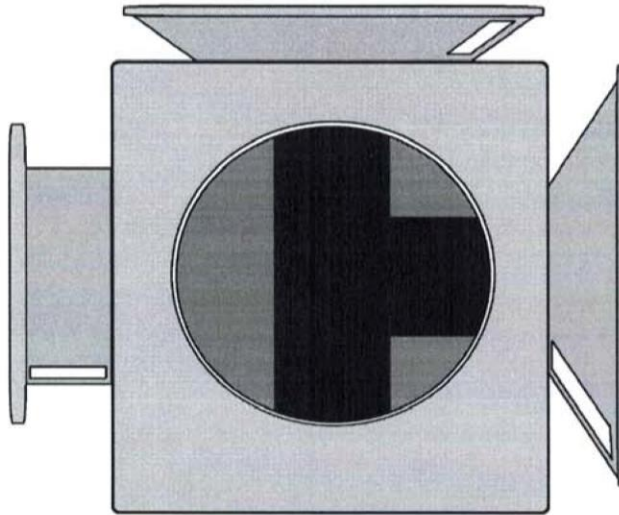

Rotary core in run position, the core arm/ clevis will be facing up and in the rearer most position

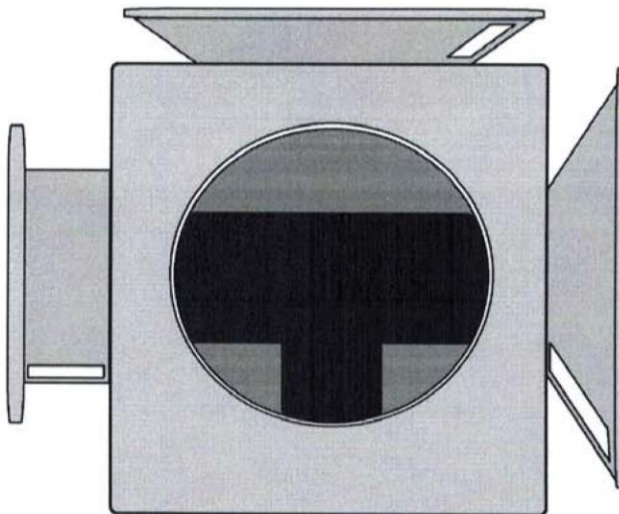

There are two arows(Shown below) pointing to the orings installed in the rotary core

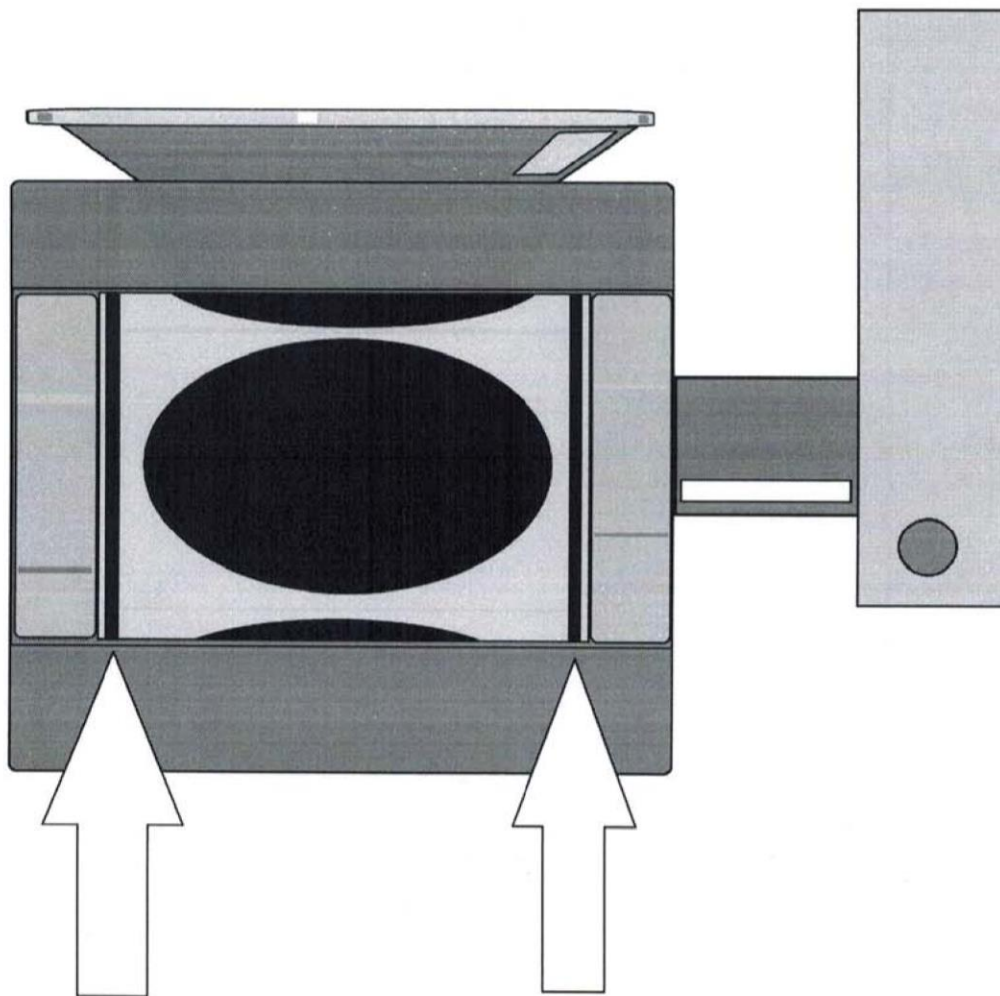

Two arrows below point to the orings on the main product piston that is housed inside of the steel product cylinder

